



ALSONIC-FX

Ultrasonic Flowmeter
Model ALSONIC-FX

GENERAL

ALSONIC-FX series is a fixed mounted, transit-time ultrasonic flowmeter, with clamp-on transducers for non-invasive liquid measurement.

Our microprocessor based, user friendly, field programmable flow measurement technique allows no interruption of the process flow and has low installation costs.

FEATURES

- 2 line LCD display with flowrate, totalizer & signal condition.
- Stores up 64 Day/months Totalizer daily value
- Batch control function
- Wide range velocities of 0.1 ~ +/- 12 m/s.
- Transducers for pipe size form 13 to 6000 mm.
- High accuracy of +/-0.5% of reading.
- Transducers include magnet devise, for installation on metal pipe without mounting belt.
- Data logger function, include date, totalizer, signal condition.. Etc.
- Response time less than 1 second.

SPECIFICATION

- | | | | |
|-----------------------|--|-----------------------|--|
| ● Measuring Principle | : Transit time difference | ● Keypad | : up to 16 Key with tactile action |
| ● Pipe Size | : S Type : 15 mm ~ 100 mm
: M Type : 50 mm ~ 700 mm
: L Type : 300 mm ~ 6000 mm | ● Response Time | : Less than 1 second |
| ● Pipe Material | : Cast Iron, Stainless Steel, Ductle Iron
Copper, PVC, Aluminum, Asbestos
Fiberglass... etc. | ● Flow Velocity | : 0.1 ~ +/- 12 m/s |
| ● Liner Material | : Tar Epoxy, Rubber, Mortar, Polypropylene,
Polystryal, Ploystryene, Polyester, Ebonite,
Polyethylene, Teflon... etc. | ● Resolution | : 0.0001 m/s |
| ● Display | : 2 Line LCD with illumination.
Flowrate : 5 digit with decimal point
Totalizer : 8 digit, Forward, Reverse & Net values.
Engineer Unit : M3, Liter, US Gallon, Imperial Gallon,
Million Gallon, Cubic Feet, US Barrels,
Imperial Barrels, Oil Barrel.
Time Unit : Second, Minute, Hour, Day.
Other : Velocity, Date, Time, Signal condition. | ● Ambient Temperature | : -20 ~ +50 °C |
| ● Accuracy | : +/- 1% ~ +/- 2% of reading(0.1 ~ 12 m/s)
: +/- 0.5% of reading (online calibration) | ● Mounting | : wall mounting, panel, local |
| ● Repeatability | : +/-0.2% of reading | ● Max. Cable Length | : 150 M |
| ● Communication | : RS485, M bus | ● Power Consumption | : Less than 2W |
| | | ● Power Supply | : 90 ~ 260Vac 50/60 Hz
24 VDC (option) |
| | | ● Data Storage | : Operation parameters and totalization
date are stored by EEPROM for more
than 10 years |
| | | ● Output | : 4-20 mA or 0-20 mA |
| | | ● Pulse Output | : 1- 9999 Hz |
| | | ● Data Logger | : SD card for wall mount
64 data include flowrate, totalizer,
time, date. |
| | | ● Alarm | : High/Low with buzzer |
| | | ● Transducer Weight | : up to 2 Kg |
| | | ● Protection | |
| | | Converter | : IP64, IP65 |
| | | Sensor | : IP65, IP68(option) |



TRANSDUCER SPECIFICATION

Standard-Transducers

Fluid Temperature : -30 ~ +80 °C

Accuracy: 1%



Model	SCS (Small Size)	SCM (Medium Size)	SCL- (Large Size)
Pipe Size	DN15-100mm	DN50-700mm	DN300-6000mm

Insertion Transducers

Fluid Temperature : -40 ~ +160 °C

Accuracy: 1%

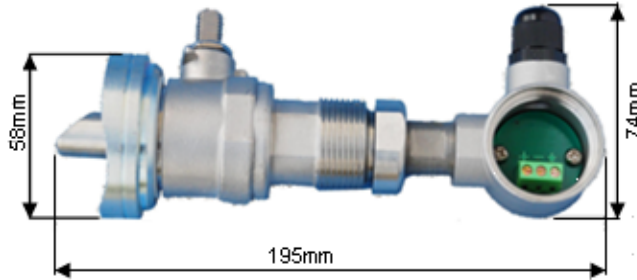

Model	SIS (Standard)	SIL (Large Size)
Pipe Size	DN80-1000mm	DN300-6000mm

High Temperature Transducers

Fluid Temperature : -30~140 °C

Accuracy: 1%



Model	STS (Small Size)	SHL (Medium Size)
Pipe Size	DN15-100mm	DN50-700mm

Inline Type

Fluid Temperature : -40~160 °C

Accuracy: 0.5%

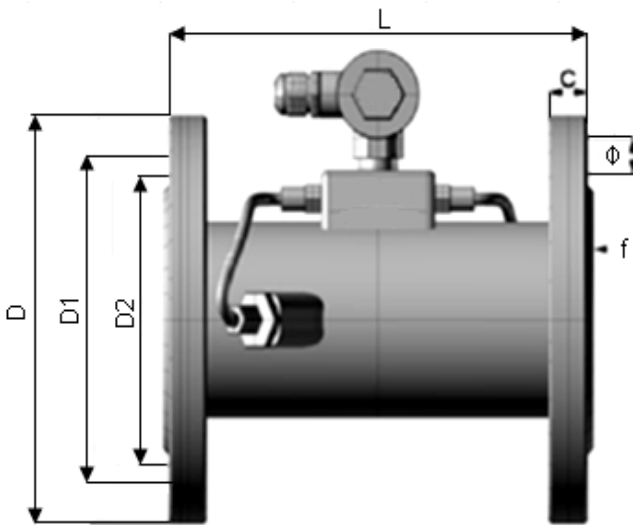

DN	L	D	D1	φ×n	D2	f	C
50	200	165	125	18×4	99	3	20
65	200	185	145	18×4	118	3	20
80	225	200	160	18×4	132	3	20
100	250	220	180	18×8	156	3	22
125	250	250	210	18×8	184	3	22
150	300	285	240	22×8	211	3	24
200	350	340	295	22×12	266	3	24
250	450	405	355	26×12	319	3	26
300	500	460	410	26×12	370	4	28
350	550	520	470	26×12	429	4	30
400	600	580	525	26×16	480	4	32
450	700	640	585	30×20	548	4	34
500	800	715	650	33×20	609	4	36
600	1000	840	770	36×20	720	5	38
700	1100	910	840	36×24	794	5	40
800	1200	1025	950	39×24	901	5	42
900	1300	1125	1050	39×28	1001	5	44
1000	1400	1255	1170	42×28	1112	5	46

Note:all dimensions are mm unless stated

OTHER ACCESSORY



Measuring Tape



Stretcher



Thickness gauge



Data logger

➤ DIMENSIONS

● Wall Mount



cast aluminium
IP65

Size: 180×170×56mm

Setting data: flow unit, zero, clear total flow, K-factor, passwords, date, linearity factor

Input: 3 channel 4-20mA analog input, 2 channel resistance signal input

Output: Isolation RS232/RS485 output, 2 channel OCT, 1 channel 4-20mA output
SD card Data logger(option)

● Compact



- Display:**
1. state
 2. error time
 3. temperature different
 4. temperature
 5. energy flow
 6. total flow
 7. flow rate

Size: 96×96×129mm

Input: 3 channel 4-20mA analog input, 2 channel resistance signal input

Output: Isolation RS232/RS485 output, 2 channel isolation OCT output
1 channel isolation 4-20mA output (option)

Protection: IP68

Power Supply: 24 VDC
Battery power(Options) - no output

Transducer: Inline and clamped type

● Mini Module



Size: 120×80×30mm

- Display:**
- | | |
|--------------------------|------------------------|
| 1. state | 5. energy flow |
| 2. error time | 6. total flow |
| 3. temperature different | 7. flow rate |
| 4. temperature | 8. positive total flow |

Output: RS485, OCT, 4~20mA(option) .

Protection: IP65

● Water meter



- Display:**
1. state
 2. total flow
 3. flow rate

Size: 96×96×129mm

Transducer: Inline type

Power Supply: Battery power(Options)

Output: Std - none
Opt - pulse

Protection: Std - IP65
Opt - IP68

➤ STRAIGHT RUN PIPING REQUIREMENT

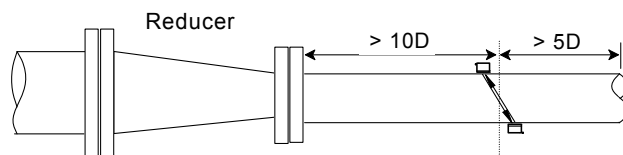
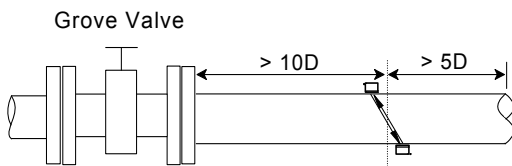
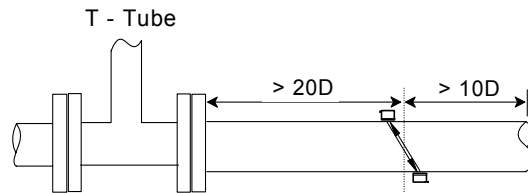
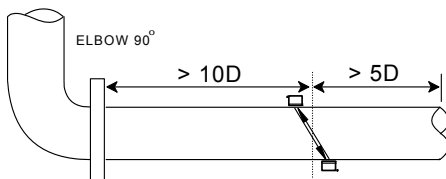

INSTALLATION

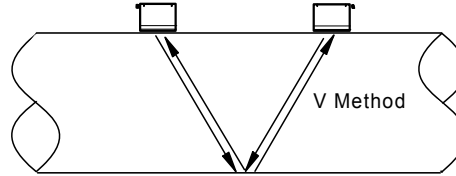
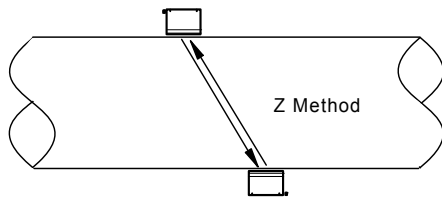





**** Please contact your local SMC application engineer**

You also need to provide the following information:

Type of Fluid	We need the name of your fluid, including operating density and viscosity
Line Size	pipe size and sensor connection type (insertion,clamp, etc..)
Process Pressure and Temperature	We calibration your Flowmeter as close to your application as possible
Type of Electronics	output and install type (compact, wallmount, panelmount,etc..)
Pipe Material	We need the name of your pipe material

Model Selection Guide

ALSONIC-FX						
Example 1: ALSONIC-FX-CPF-SCS-C1						
ALSONIC-FX-	**	**	**	**	**	Description
Remote Mini Module with display and RS485 	MUF					Flow meter
Compact-multichannel with display,RS485,OCT output 	CPF					
Wall mount with display, multichannel input/outputs 	WLF					
Water meter with display, battery power 	WM					
Small clamp sensor, 15 ~ 100 mm		SCS				Transducers
Middle clamp sensor, 50 ~ 700 mm		SCM				
Large clamp sensor, 300 ~ 6000 mm		SCL				
High Temperature clamp sensor (-30-140℃), 15 ~ 100 mm		SHS				
High Temperature clamp sensor (-30-140℃), 50 ~ 700 mm		SHL				
Standard insertion sensor		SIS				
Long insertion sensor		SIL				
Inline sensor with pipe size ***		SN-***				
No Cables			NC			Signal Cable Length
5M, 2 Cables			C1			
10M, 2 Cables			C2			
15M, 2 Cables			C3			
Wall mount transmitter				TW		Transmitter
Panel mount transmitter				TP		
None transmitter				NN		
thinkness gague					TT	Options
Data logger					DL	
Protection IP68 for transducer					68	