



ALSONIC-AVM

Open Channel Area-Velocity Flowmeter
ALSONIC AVM Series

GENERAL

SMC's ALSONIC-AVM system is an area-velocity meter that is used in conjunction with a user-supplied level transmitter to measure flow rates in open channels. The ALSONIC-AVM, which consists of an advanced DSP-based flow computer and four transducers, uses the transit time difference of ultrasonic sound pulses to measure the open channel flow velocity. The ultrasonic pulses are transmitted upstream and downstream across the channel at an angle α between the flow direction and the sonic wave path, with the difference in the sonic wave's transit time being directly proportional to the liquid velocity.

The ALSONIC-AVM may be used in rectangular, circular, trapezoidal or other shaped channels. Since the transducers create almost no restriction, virtually no head loss is created. The advanced DSP-based flow computer with cross-correlation and FFT technology allows this system to work in the most difficult applications, including those involving liquids with high concentrations of suspended solids & air or a large noise component.

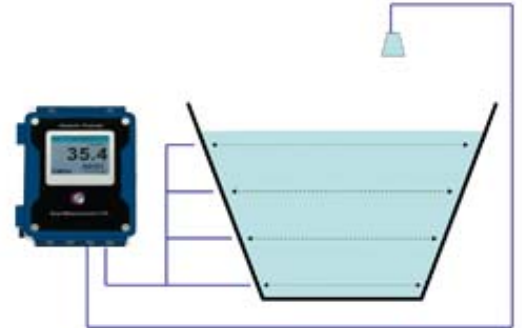

FEATURES

- Color graphic LCD display 128x64 for flow rate, total flow & signal shape
- 32 Mbyte datalogger; up to 200,000 data fields
- No-moving-parts design creates no pressure loss
- Velocities from 0.03 ~ 40 feet/sec (0.01 ~ ± 12 m/s)
- Any liquids containing ≤ 30% suspended solids, including waste water
- High open-channel accuracy; ±2.0% of reading
- Oscilloscope function for diagnostics
- AR (Anti-Round) Mode (patent pending)
- Fine Time Measurement Technology (Patented)
- Data logger function; includes date, totalizer, diagnostics
- Response time less than 1 second



SPECIFICATIONS

- | | |
|--|---|
| <ul style="list-style-type: none"> • Measuring principle: Ultrasonic transit-time differential, 4-path • Channel geometries: Rectangular
Circular
Trapezoidal
Other (Consult SMC factory) • Max pass length: 78.74' (24m) • Min pass length: 2.46' (750 mm) • Display:
Flowrate: 4 ½ digit
Totalizer: 10-digit, Positive, Negative & Net values
Engineering Units: m³, Liter, US Gallon, Imperial Gallon, Million Gallon, Cubic Feet, US Barrels, Imperial Barrels, Oil Barrel • Keypad: 16 key with tactile action • Accuracy: ±2.0% of reading • Repeatability: ±1.0% of reading • Turn down ratio: 1000:1 • Response time: Less than one second • Velocity range: ±0.03~40 feet/sec (±0.01-12 m/s) • Resolution: 0.003 feet/sec (0.001 m/s) | <ul style="list-style-type: none"> • Ambient Temp.: -4~140 °F (-20~60 °C) • Power Supply: 90~250 V_{AC}, 50/60 Hz, DC Option • Power Consumption: Less than 20 W • Outputs: 4-20 mA_{DC}, relay, RS-232C • Input: 4-20 mA_{DC} • Max cable length: 650' (200m) • Data logger: 32 Mbytes; up to 200,000 fields • Alarm: Two relays for total/hi flow • Communication: 2 RS-232/RS485 • Data storage: EPROM storage up to 10 years • Dimensions: See pages 2-3 • Weight: • Enclosure Mounting: Wall mount • Transducer mat'ls: Stainless steel #316 (housing & sphere)
Polycarbonate (lens) • Protection
Converter: NEMA 4 (IP 65)
Transducers: NEMA 6P (IP68) - Submersible |
|--|---|

SmartMeasurement

10437 Innovation Drive, Suite 315, Milwaukee, WI 53226
TEL : +1-414-299-3896 FAX : +1-414-433-1606



ALSONIC-AVM

Open Channel Area-Velocity Flowmeter
ALSONIC AVM Series

➤ Transducer Specifications

- Standard Transducers**

Fluid temperature: -40~248 °F (-40~120 °C)

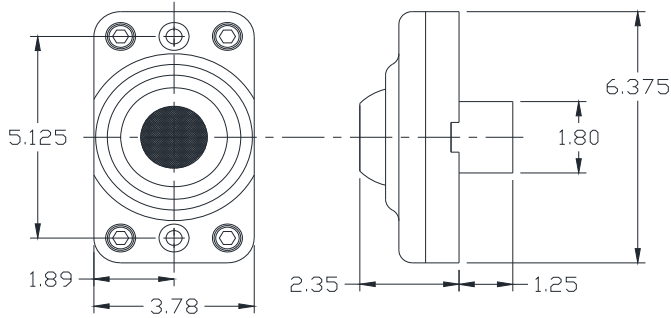

Large Transducers (LTO-6)

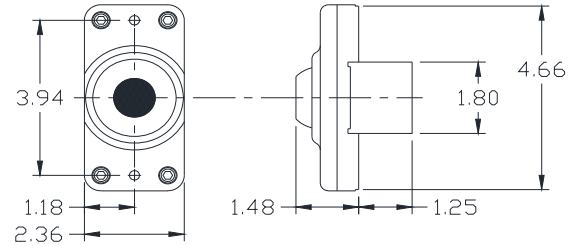

Small Transducers (LTO-2)

➤ Mounting Hardware

Large Transducers

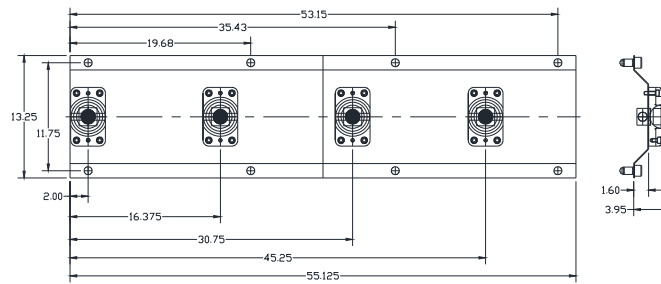

Small Transducers

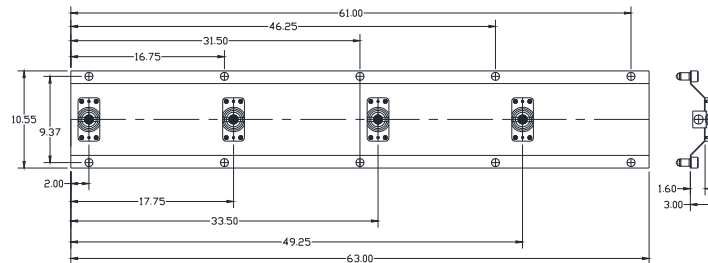

➤ Oscilloscope Function

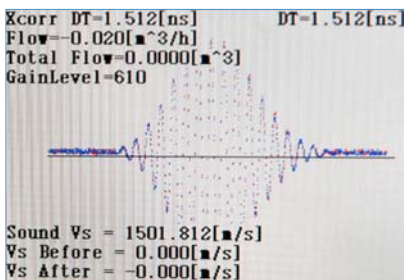

SmartMeasurement

10437 Innovation Drive, Suite 315, Milwaukee, WI 53226
TEL : +1-414-299-3896 FAX : +1-414-433-1606



ALSONIC-AVM

Open Channel Area-Velocity Flowmeter
ALSONIC AVM Series

➤ Display Enclosure

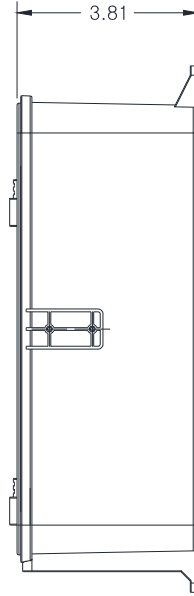
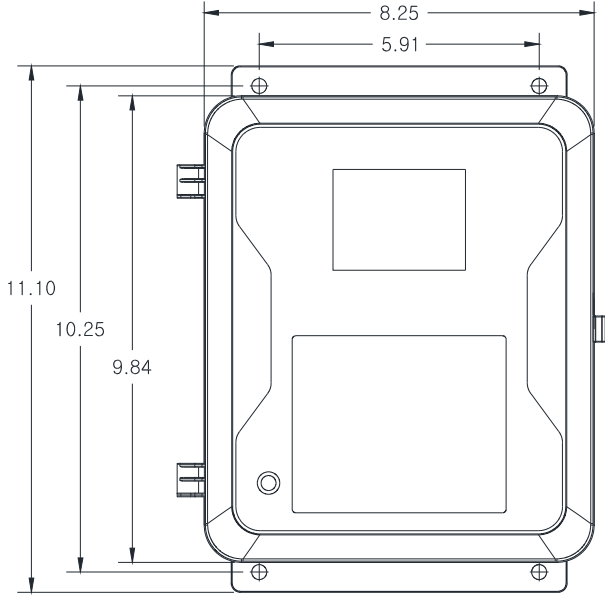

PANEL HOLE LAYOUT

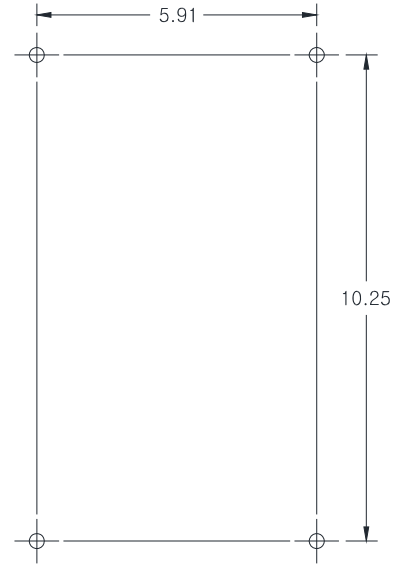

➤ Wiring Connections

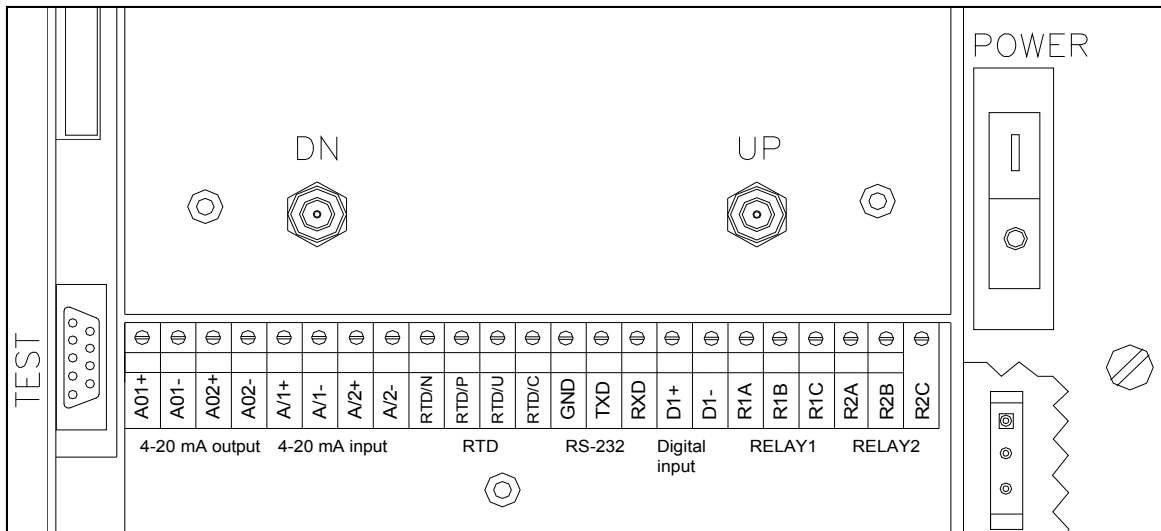



ALSONIC-AVM

Open Channel Area-Velocity Flowmeter
ALSONIC AVM Series

Please contact your SMC application engineer

You also need to provide the following information:

Type of fluid
Channel Geometry
Process Temperature
Type of electronics
Level Instrument

Please provide the name of your fluid, including operating density and viscosity
Please specify the type of channel (rectangular, circular, trapezoidal)
We will calibrate your flowmeter as close to your operating conditions as possible
Please specify output and installation type (wall mount, panel mount, etc.)
Please provide a make & model for the level transmitter that will be used

➤ Model Selection Guide

ALSONIC-AVM							
Example 1: Alsonic-AVM-100MC-(#)LTO-2-(#)MTO-C10							
Alsonic-AVM-	**	**	**	**			Description
NEMA 4 with keyboard, up to 2 path/channel	100L						Flow meter
NEMA 4 with keyboard, up to 4 path/channel	100LM						Flow meter
Open channel transducer for <2m distance		LTO-2					Transducer
Open channel transducer for >2m distance		LTO-6					
Mounting track open channel			MTO				Mounting rack
Cable length (standard is 10 m)				Cxx			Extra Cable

Notes: Display: Color Graphic LCD 128x64 with backlight

Flowrate: 4 ½ digit (XX.XXX,)

Totalizer: 10-digit, Positive, Negative & Net values (XXX: XXXXXX,)

Engineering Units: m3, Liter, US Gallon, Imperial Gallon, Million Gallon, Cubic Feet, US Barrels, Imperial, Barrels, Oil Barrel

Level: XX.XX digit (XX.XX for water level, X are the digits)

Security: password protected, access only by authorized person for programming and download of data

Data logger setting: Ability to change time interval anywhere from 600-24 hours
Data logger functions; includes date, time, flow, totalizer, diagnostics